

All rights reserved, Copyright Kradex 2015		
Product model	Enclosure Z110 - assembly	
Format: A3	Material: PS, ABS	
Scale 1:1	Tolerance: +/- 0.5	

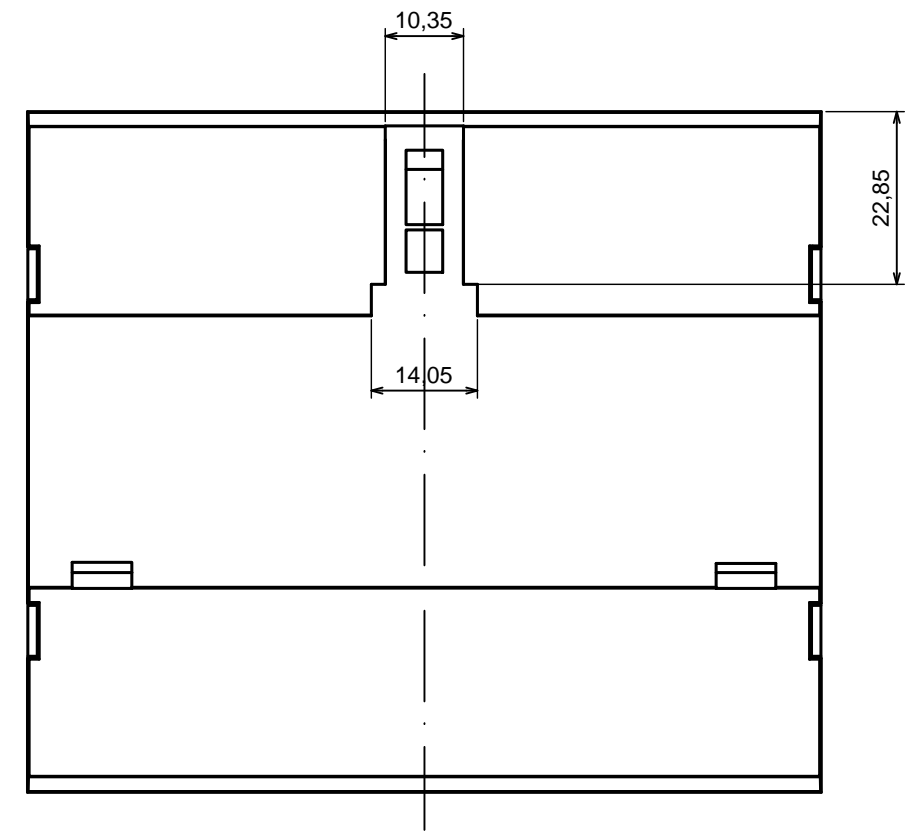
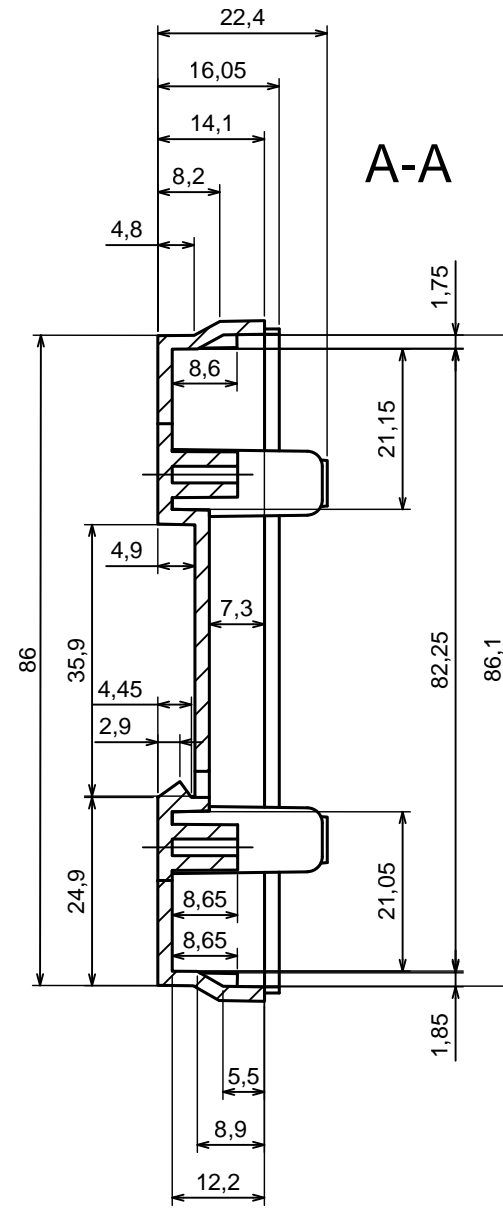
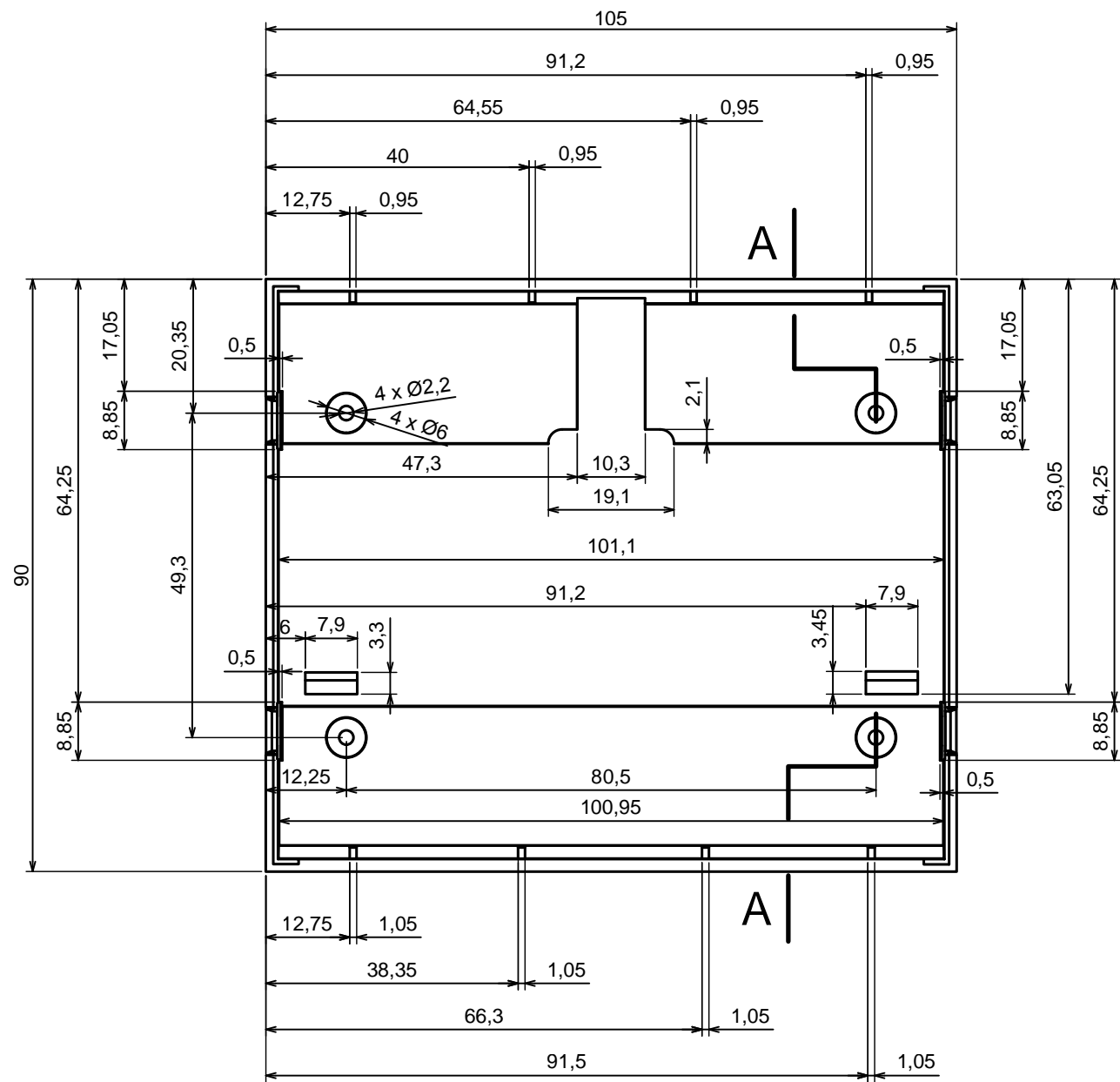

All rights reserved, Copyright Kradox 2015

Product model Enclosure Z110 - base

Format: A3 Material: PS, ABS

Scale 1:1 Tolerance: +/- 0.5



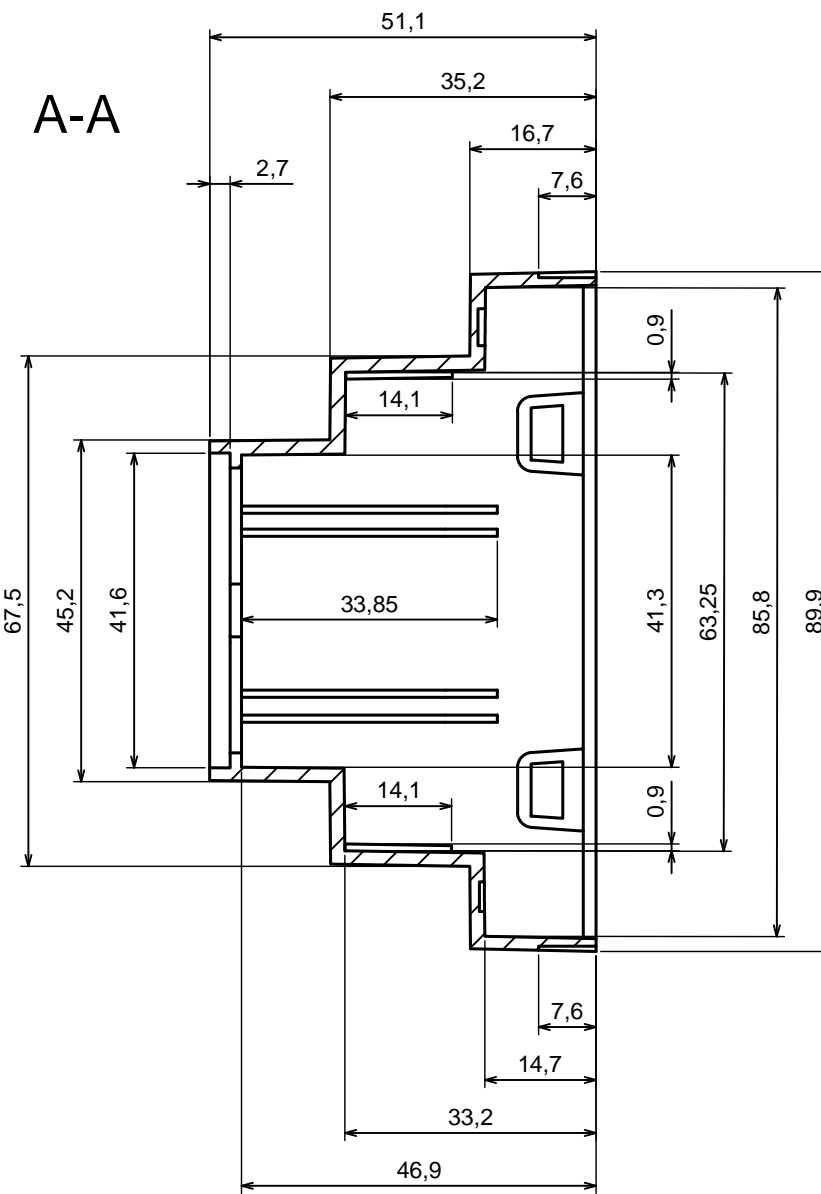
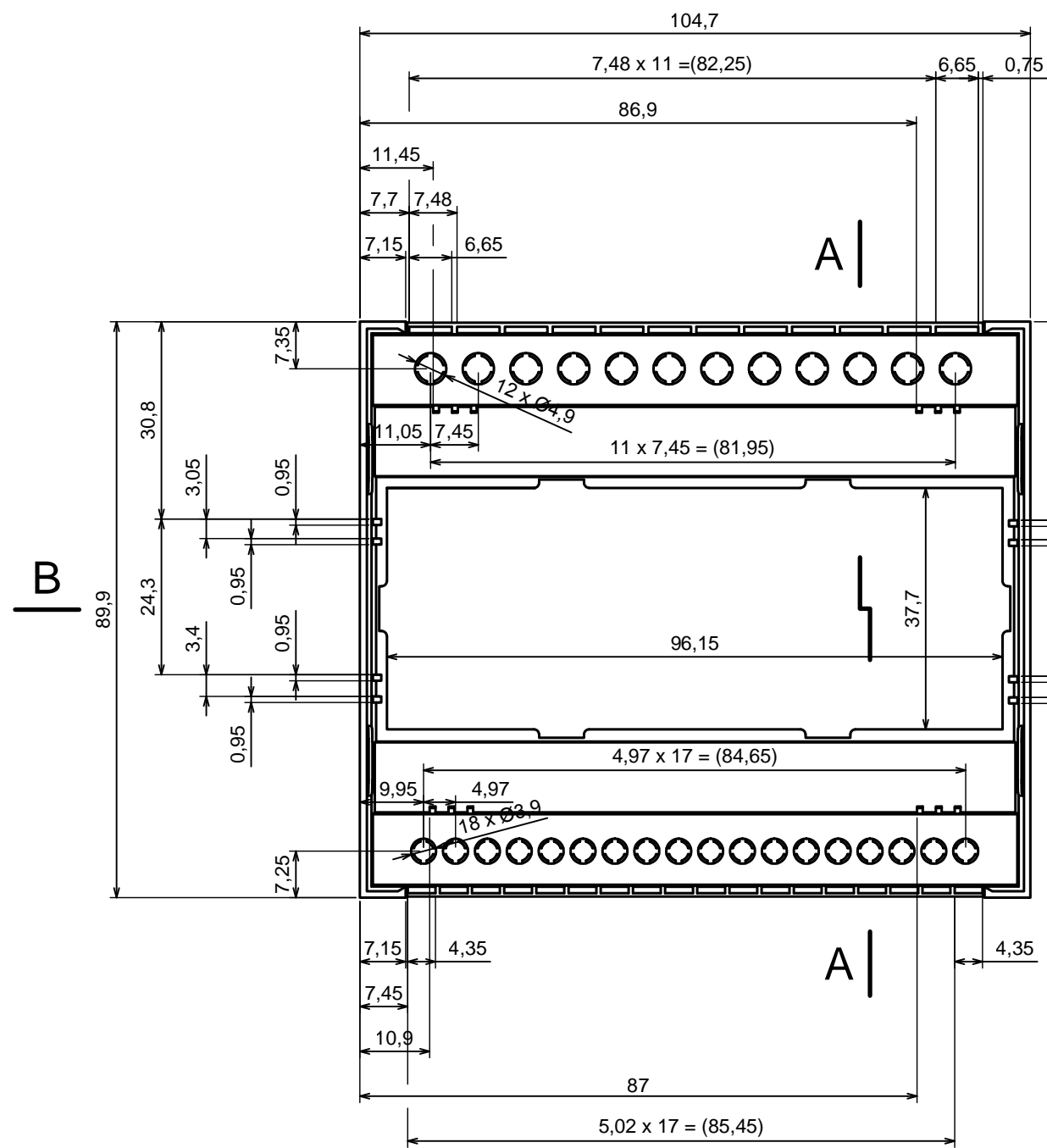

B-B

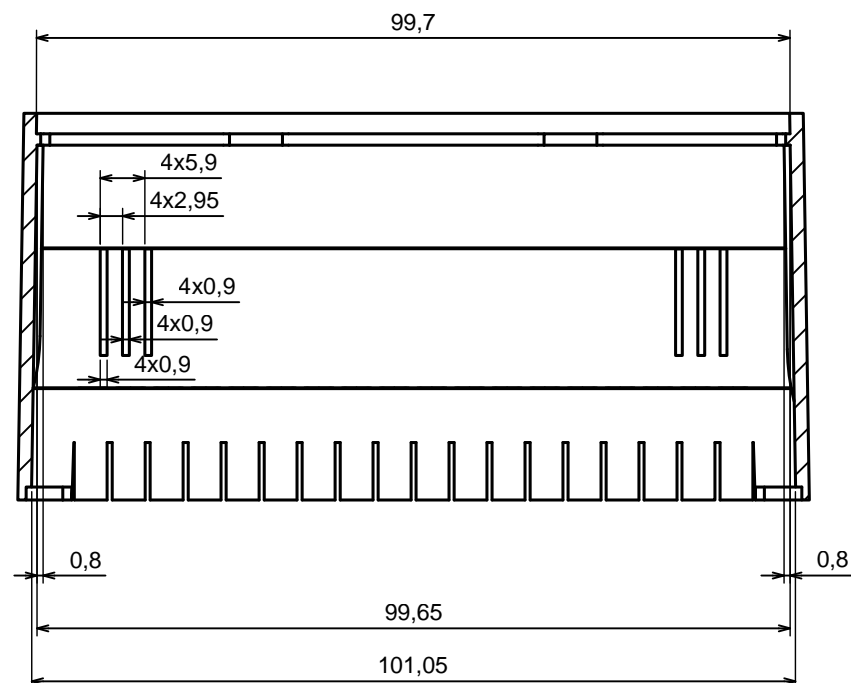

All rights reserved, Copyright Kradox 2016

Product model Enclosure Z110 - cover

Format: A3 Material: PS, ABS

Scale 1:1 Tolerance: +/- 0.5



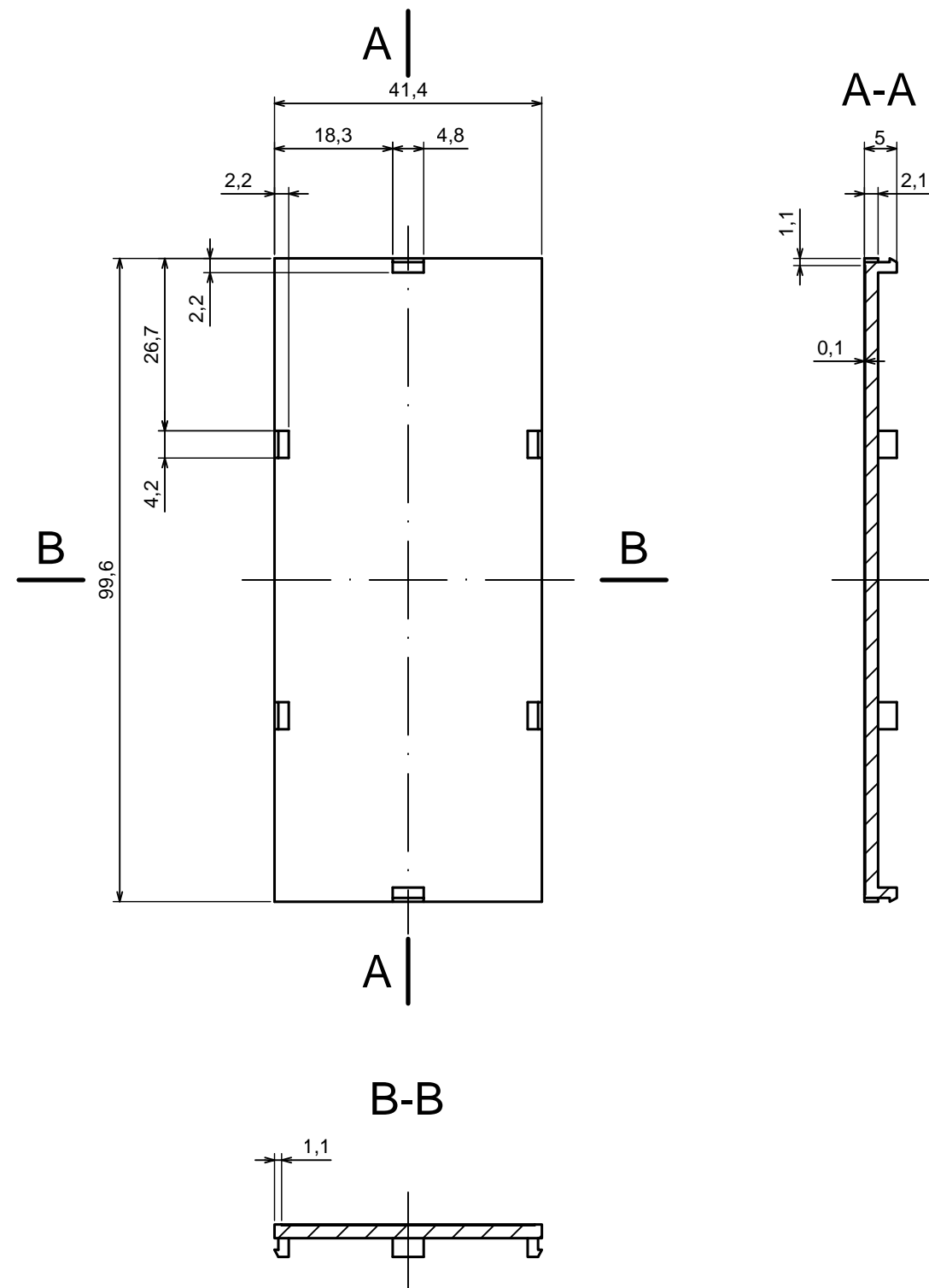

All rights reserved, Copyright Kradox 2016	
Product model	Enclosure Z110 - filter
Format: A3	Material: PS, ABS
Scale 1:1	Tolerance: +/- 0.5



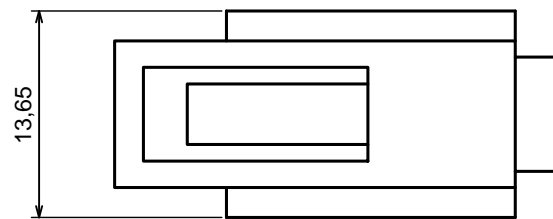
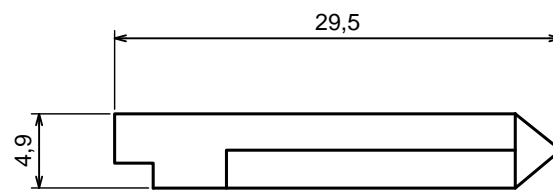

All rights reserved, Copyright Kradex 2016

Product model Enclosure Z110 - hook

Format: A3 Material: PS, ABS

Scale 2:1 Tolerance: +/- 0.5

