

All rights reserved, Copyright Kradex 2017		
Product model	Enclosure Z69U - Assembly	
Format: A3	Material: PS, ABS	
Scale 1:1	Tolerance: +/- 0.6	

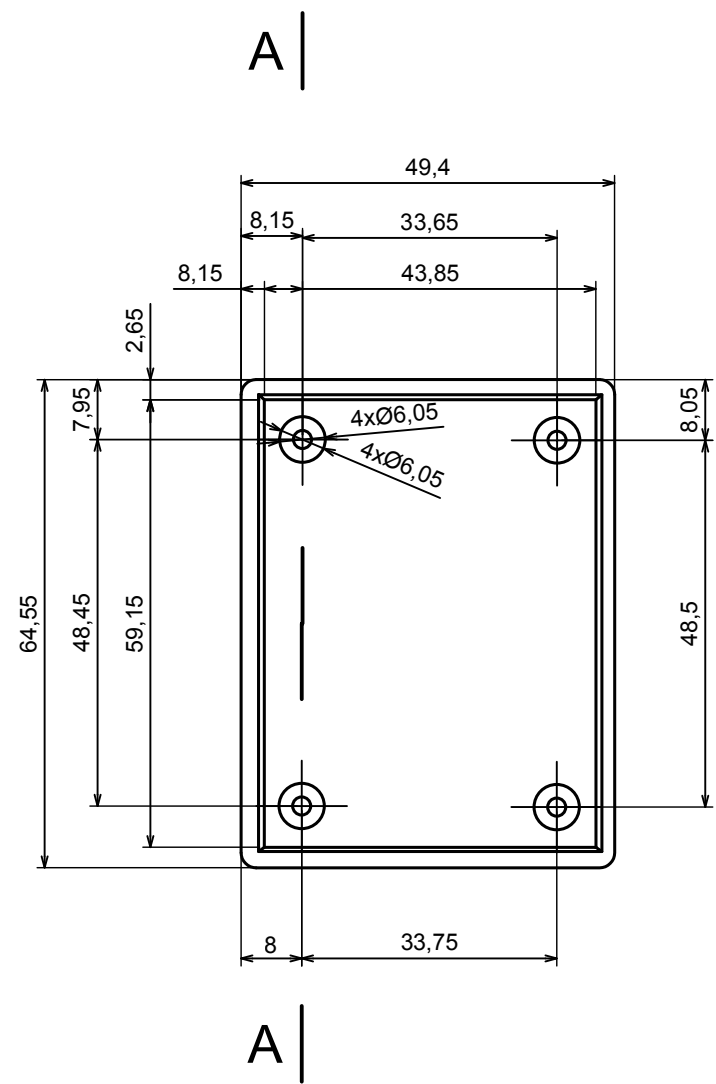

A-A

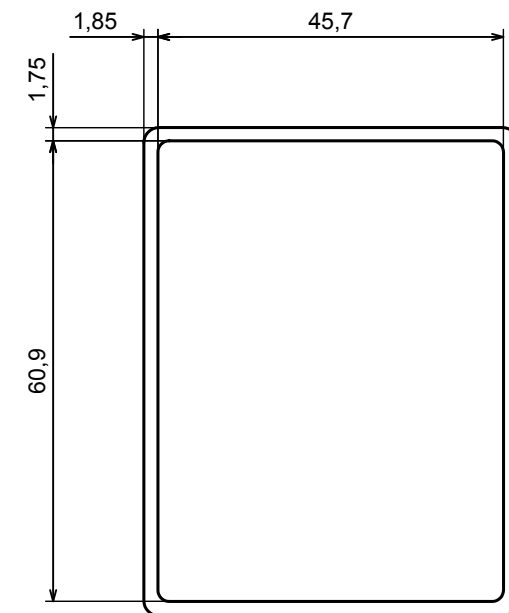
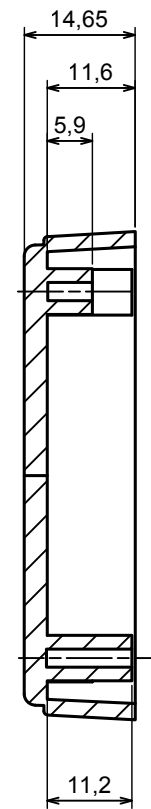

All rights reserved, Copyright Kradox 2017

Product model Enclosure Z69U - Base

Format: A3 Material: PS, ABS

Scale 1:1 Tolerance: +/- 0.6



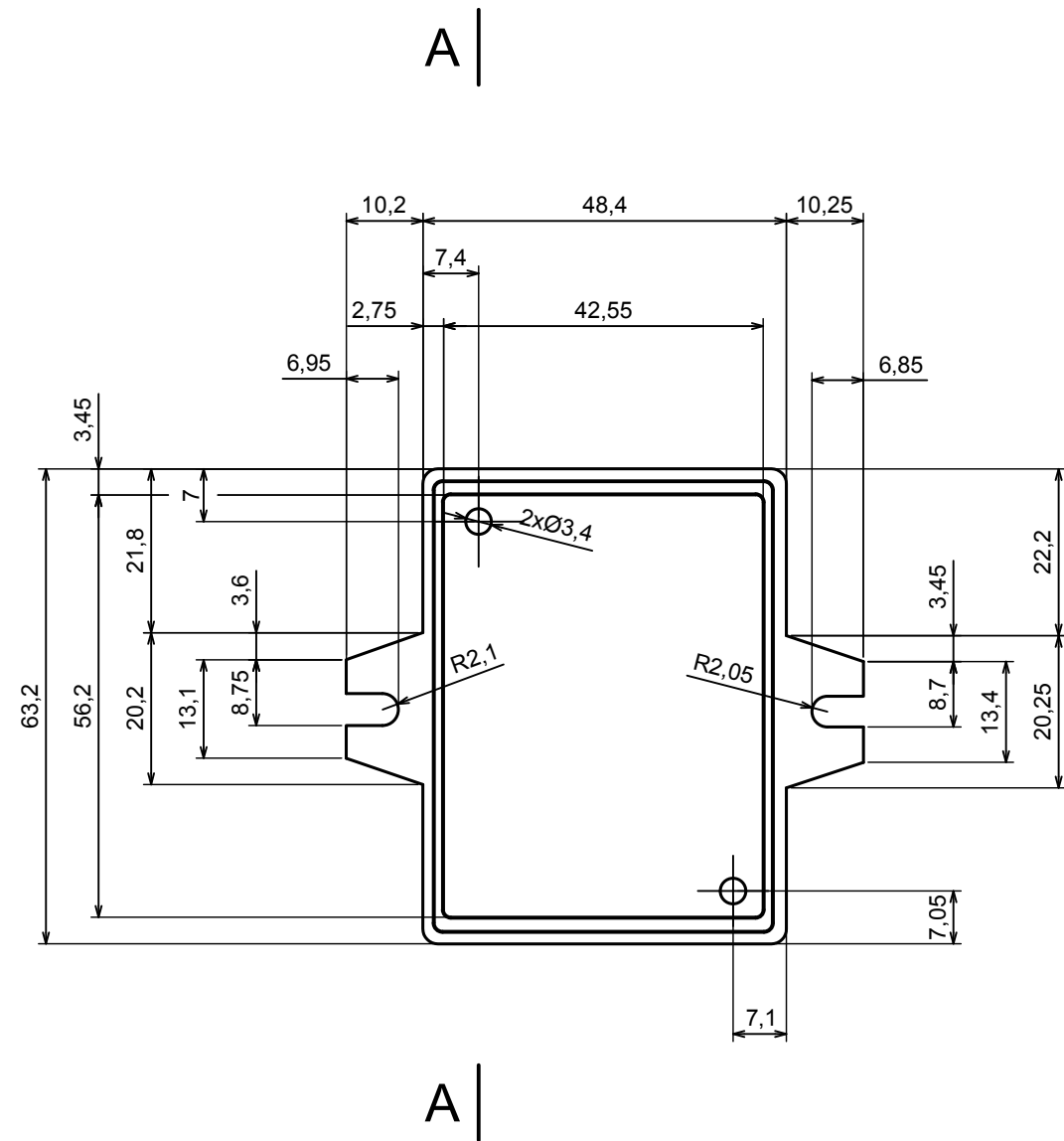

A-A

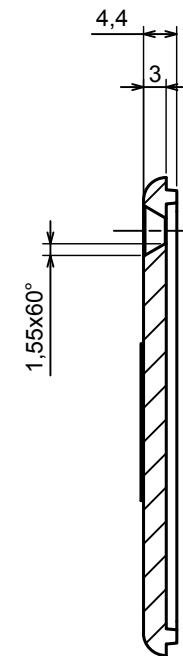

All rights reserved, Copyright Kradox 2017		
Product model	Enclosure Z69U - Cover	
Format: A3	Material: PS, ABS	
Scale 1:1	Tolerance: +/- 0.6	