

All rights reserved. Copyright Kradox 2023		
Product model	Enclosure ZM4.3 - Assembly	
Format: A3	Material: ABS	
Scale 1:1	Tolerance: +/- 0,5	

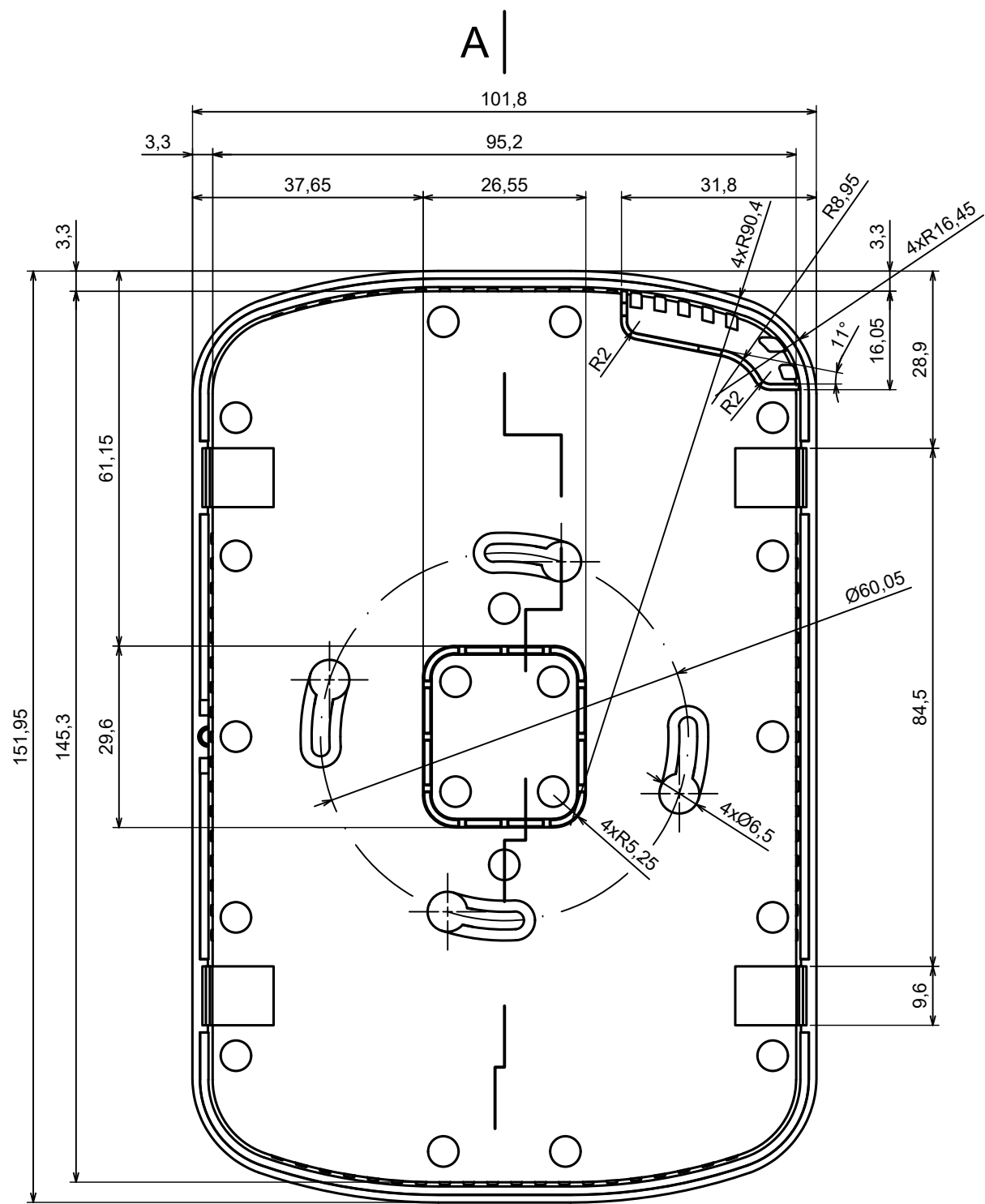

A |

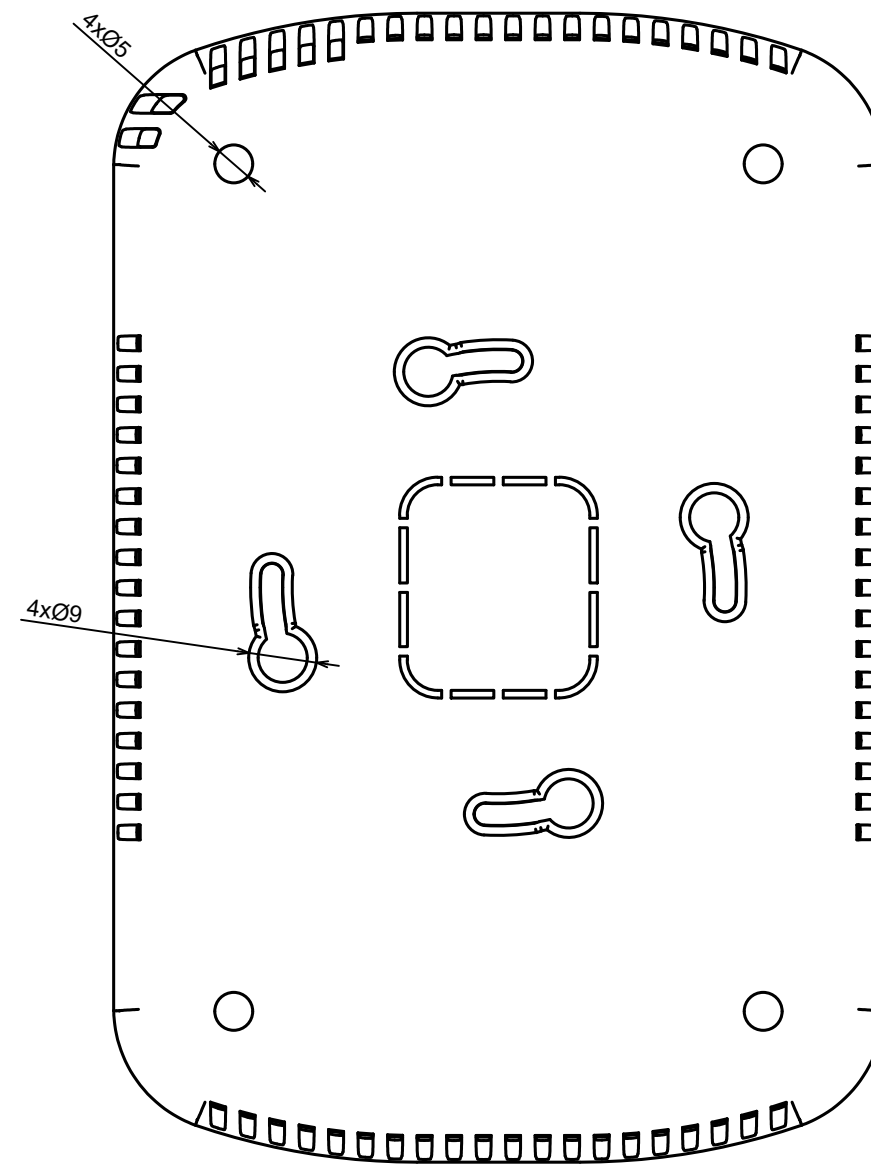
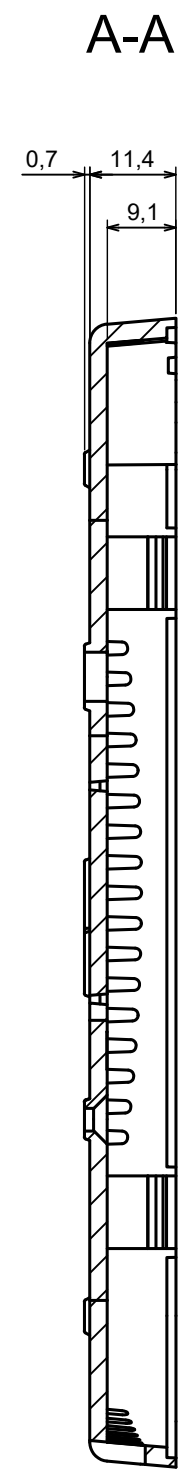

All rights reserved. Copyright Kradox 2023

Product model: Enclosure ZM4.3 - Base

Format: A3 | Material: ABS

Scale 1:1 | Tolerance: +/- 0,5



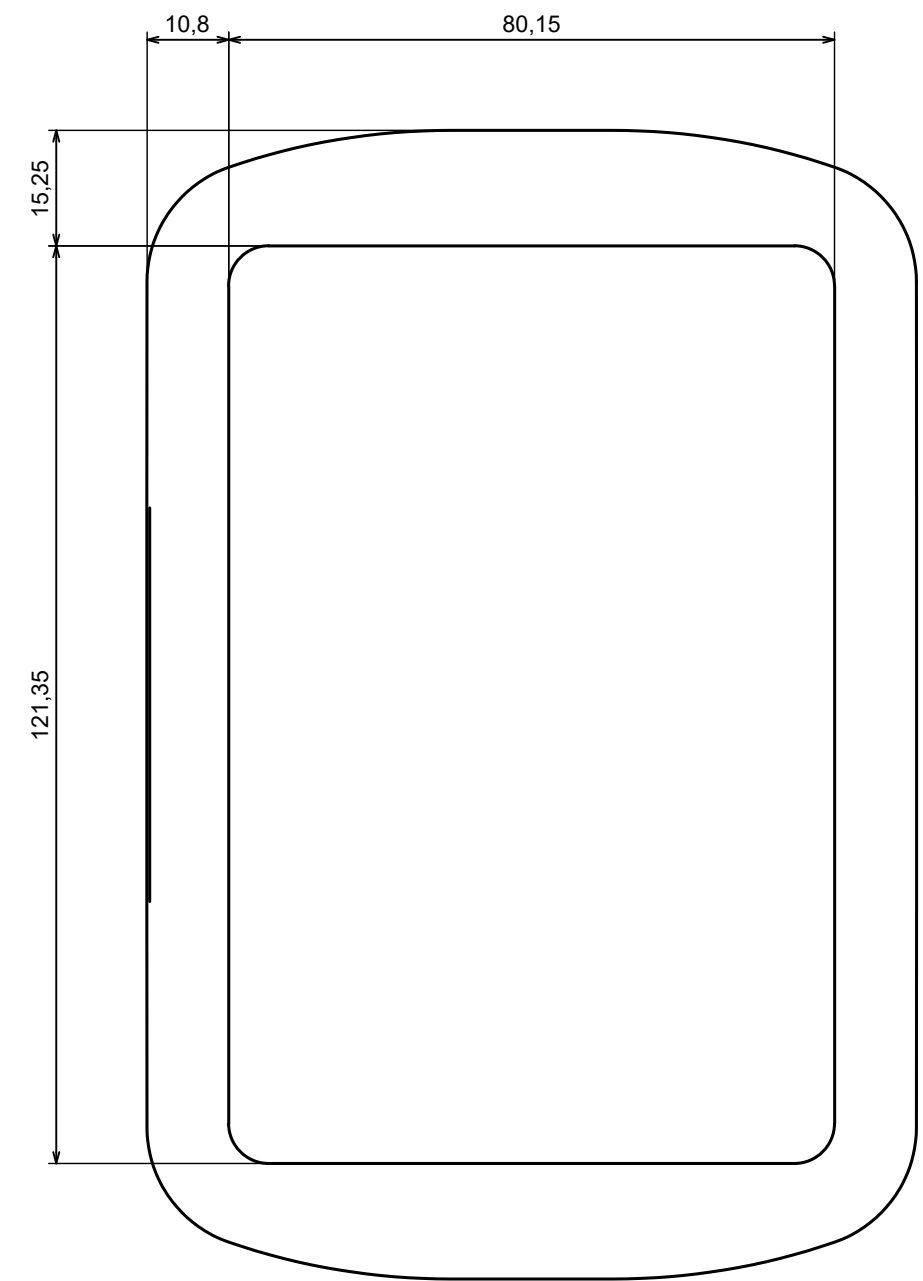
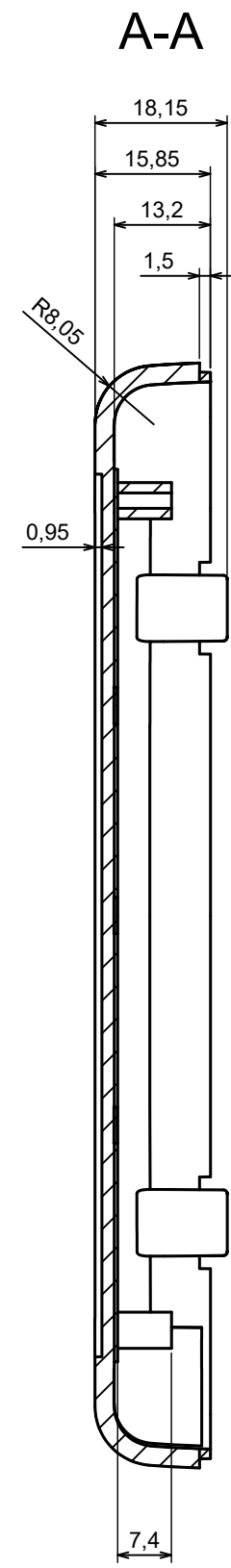
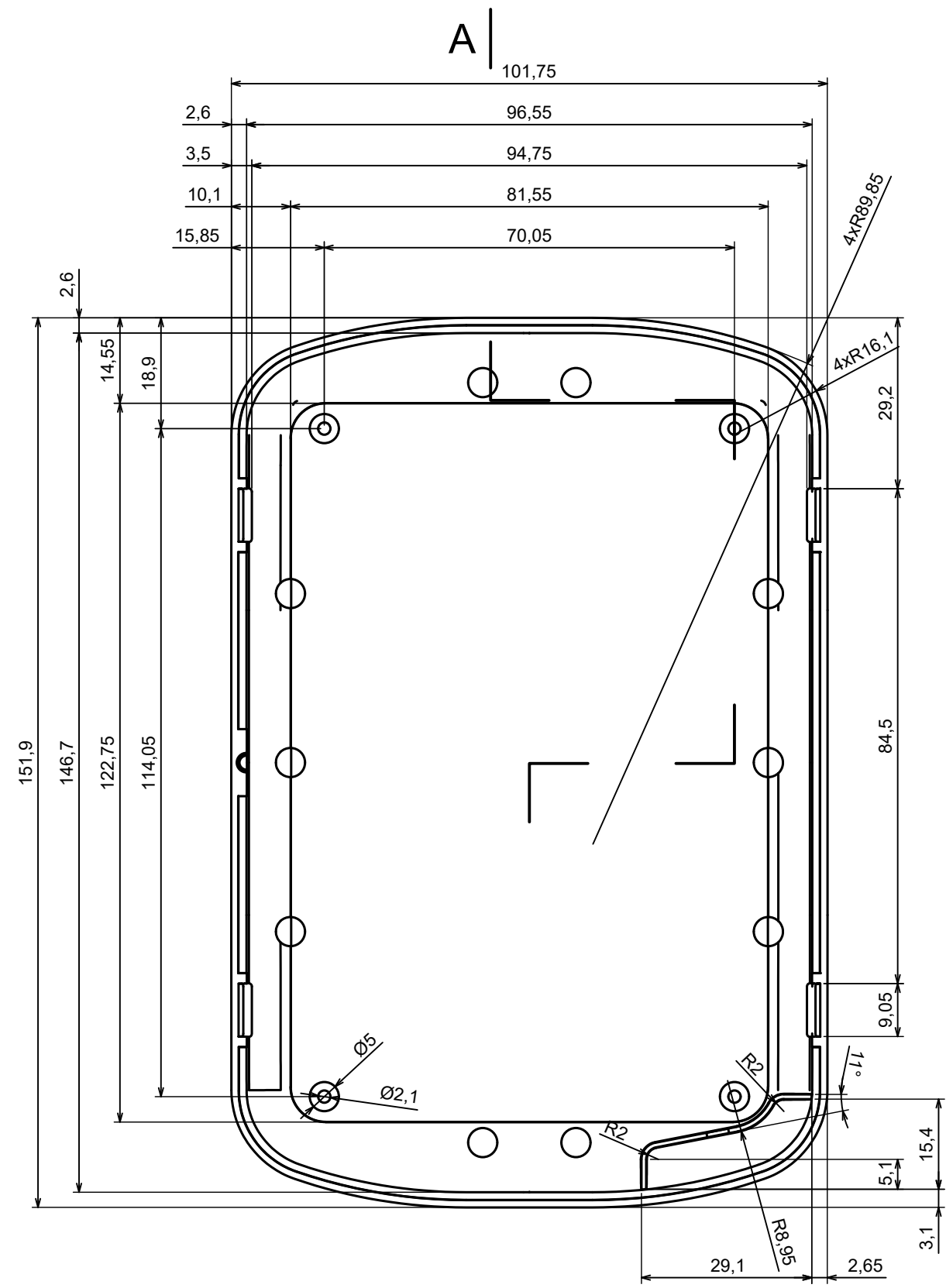

A |

All rights reserved. Copyright Kradex 2023		
Product model	Enclosure ZM4.3 - Cover	
Format: A3	Material: ABS	
Scale 1:1	Tolerance: +/- 0,3	