

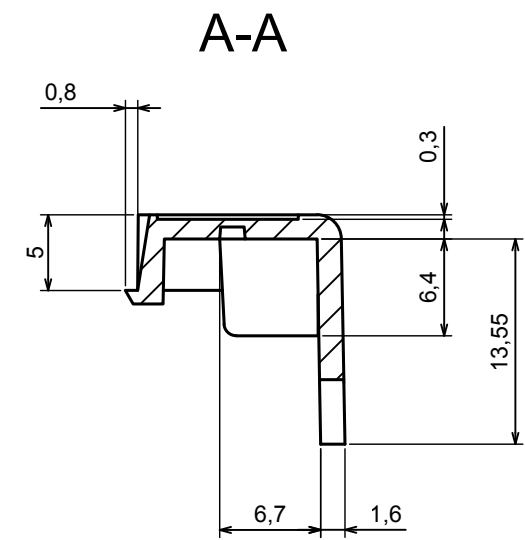

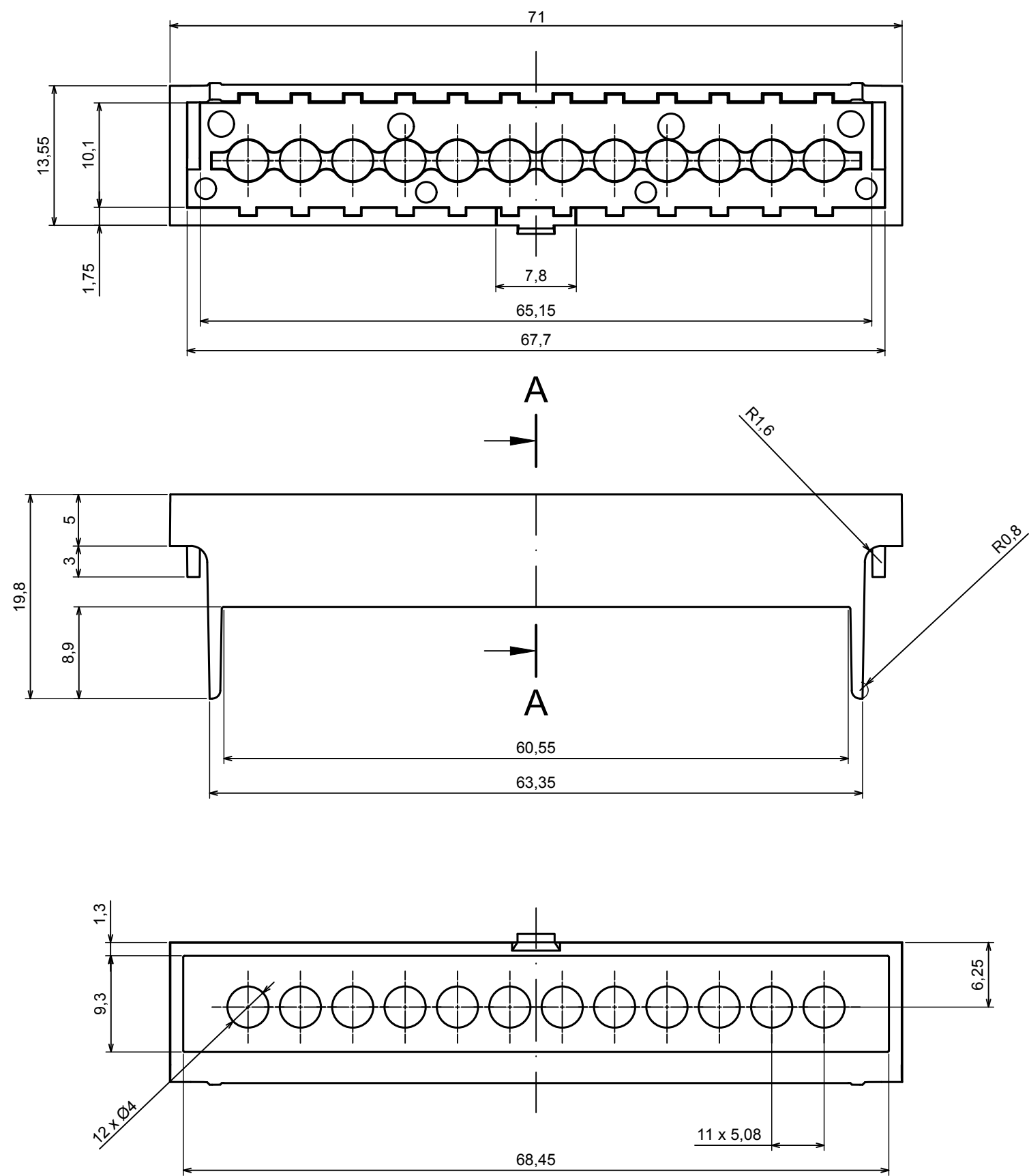

All rights reserved. Copyright Kradox 2020		
Product model	ZD4TC 5,08 - Assembly with ZDPLUG 5,08	
Format: A3	Material: ABS	
Scale 2:1	Tolerance: +/- 0,5	



All rights reserved. Copyright Kradox 2020		
Product model	ZD4TC 5,08	
Format: A3	Material: ABS	
Scale 2:1	Tolerance: +/- 0,5	

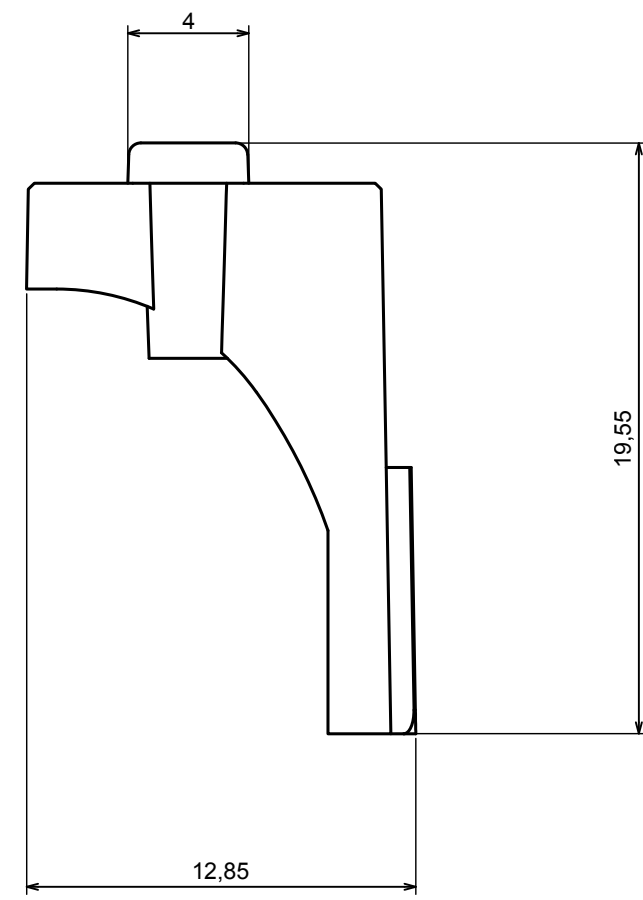
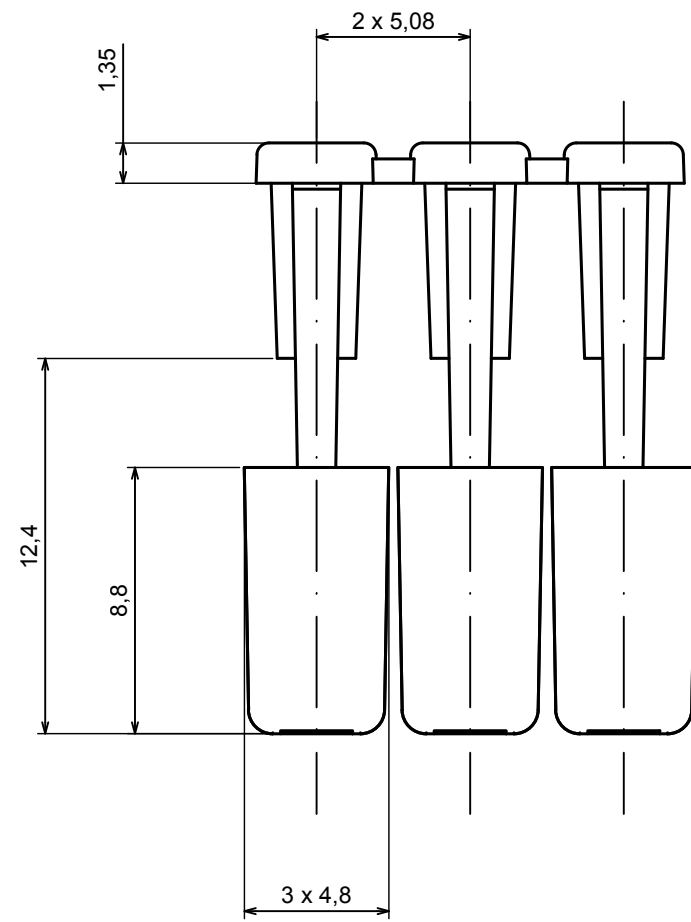

All rights reserved. Copyright Kradox 2020		
Product model	ZDPLUG 5,08	
Format: A3	Material: ABS	
Scale 4:1	Tolerance: +/- 0,5	